

QUICK START

1. Mounting the DATALUX.LT

Only attach the DATALUX.LT system with the appropriate mounting brackets. Mount these mounting brackets directly against the ceiling or with a steel cable, chain or threaded rod. Then click the fixtures in these mounting brackets. When mounting the DATALUX.LT fixtures, a mounting bracket must be attached every 1.6 meters (maximum). Make sure you mount the fixtures as straight as possible with the lenses downwards for the best light distribution.

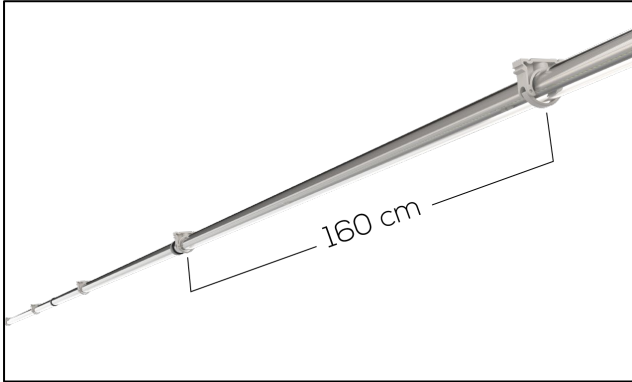

2. The DATALUX.LT connection

To connect the DATALUX.LT fixtures, the connectors must be pushed into each other. Then the metal U-lock will be used to lock the connection.



3a. Connecting PLUG.IN D000

If you do not use additional functionalities such as dim control, TRONICS and / or CAP.LOOPS, you can connect the light line with the PLUG.IN D000. You can connect these to the first lamp and the connector to the LUX series power supply. (See next page)

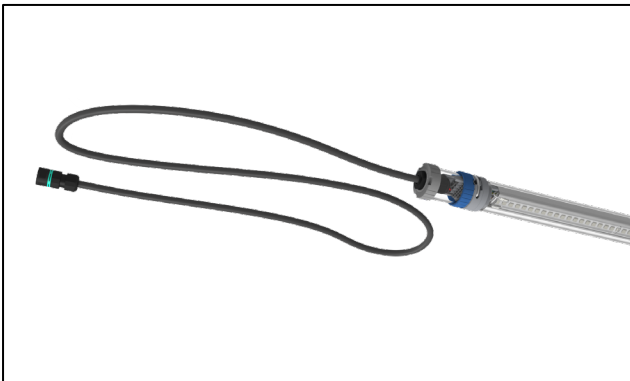

3b. Connecting PLUG.IN DECA

Do you want to use dim control, TRONICS and / or CAP.LOOP's then you have to use the PLUG.IN DECA. The connector for the LUX series power supply is pre-assembled, the rest you have to connect yourself. (See next page)

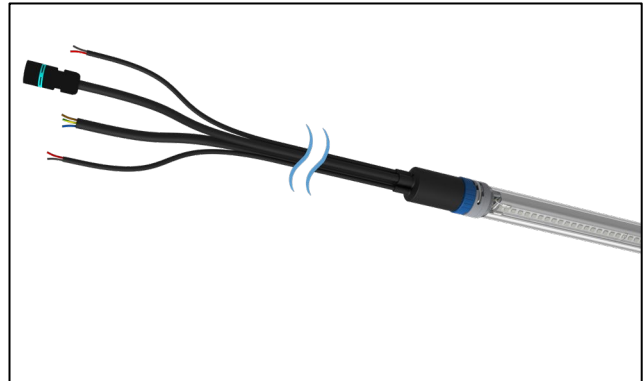

4. DATALUX.LT CAP.LOOP and/or TRONICS

Use the CAP.LOOP to supply extra long light lines with power. Place the CAP.LOOP between two DATALUX.LT fixtures and secure both connections by using U-lock's. Then connect a LUX series power supply to the CAP.LOOP.

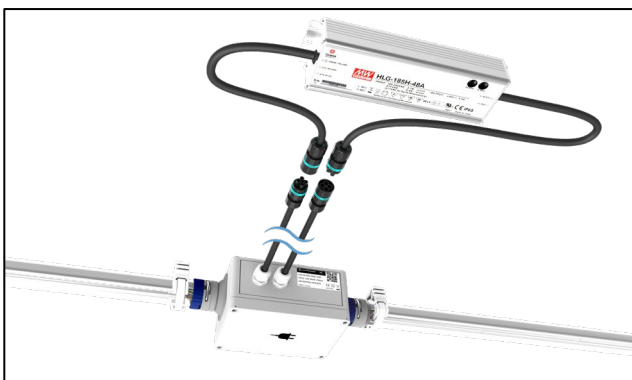

5. End of the light line

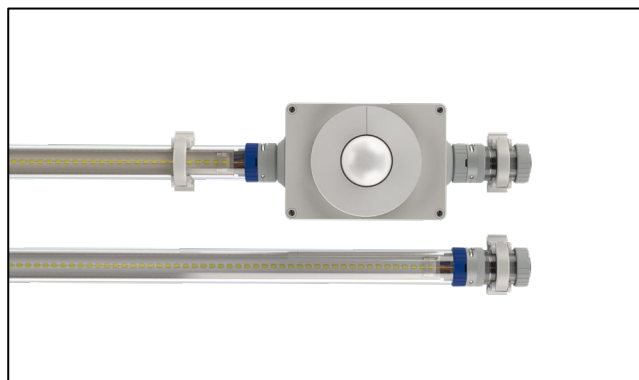

A PLUG.END is placed at the end of the DATALUX.LT light line. When a TRONIC is placed at the end of the light line you can also close the line with a PLUG.END. This ensures a dust and waterproof seal and also an extra suspension option.

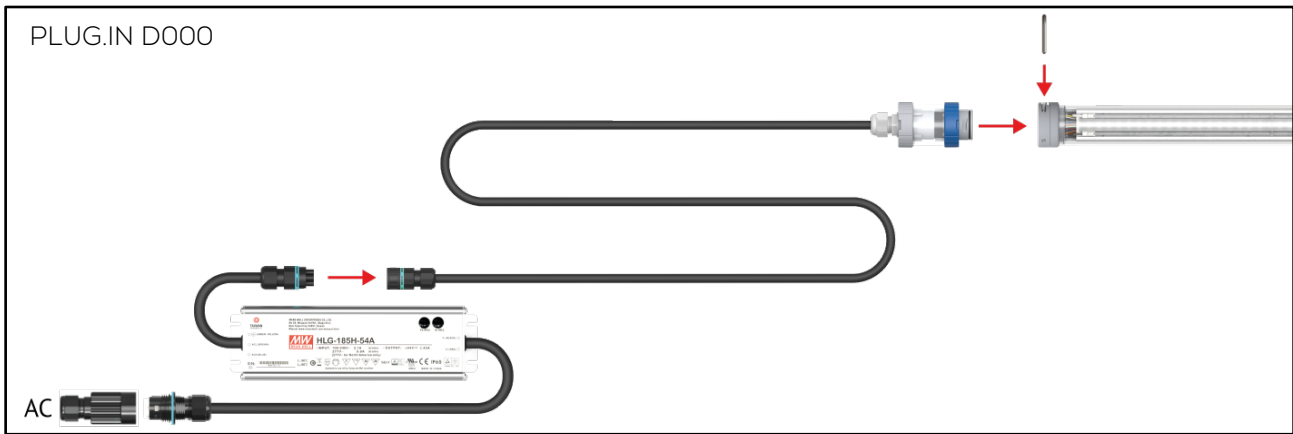

6. Connection overview PLUG.IN







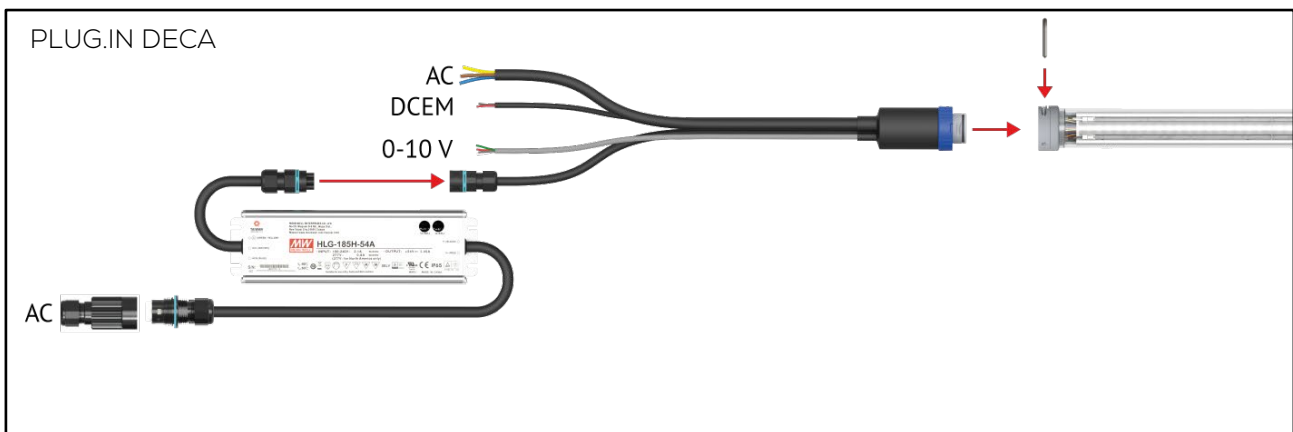





PLUG.IN D000 connections

AC LUX series power supply		L	Line	The LUX series power supply can be connected to your installation via the supplied waterproof connector.
		PE	Earth	
		N	Neutral	



PLUG.IN DECA connections

AC LUX series power supply		L	Line	The (first) LUX series power supply can be connected to your installation via the supplied waterproof connector.
		PE	Earth	
		N	Neutral	
AC Throughput for CAP.LOOP's and TRONICS		L	Line	Via the 3 x 2,5mm ²
		PE	Earth	
		N	Neutral	
DCEM		+	DCEM powerbank + connection	Via the 2 x 1,5mm ² (red/black)
		-	DCEM powerbank - connection	
Dimming		D+	+ 0-10V (dimming)	Via the 4 x 0,25mm ² (red/black)
		D-	- 0-10V (dimming)	
di		Di	Digital interface	Via the 4 x 0,25mm ² (green/white)
di		Di	Digital interface	

Connecting PLUG.IN DECA

With the PLUG.IN DECA, it is important to cap all unused connections safely. Also ensure the wires of unused cables never touch each other.



This installation guide provides you with a handy help when installing the DATALUX.LT light line system. The content of the manual must therefore be known to everyone who will work on the DATALUX.LT before starting installation work.



In addition to this manual, the personnel who will install the DATALUX.LT must have followed an electro technical training and be authorized to perform installation work. The employer / contractor must ensure that his personnel and / or employees of installation companies meet the above conditions. Despite the fact that this manual has been compiled with the utmost care, it may happen that you find an unsafe situation that is not described in this manual.

Luminaid B.V. requests that you mention this.

In spite of the fact that safety constantly has our attention and we try to prevent dangerous situations as much as possible, it remains impossible to make work totally risk-free. The safety instructions described in this document must always be read and strictly observed in combination with the safety regulations that apply within your company and / or on the construction site! Make sure that you are always alert to unexpected situations. One moment of negligence can have far-reaching consequences. Read all instructions carefully and inform the employer / contractor if there are any uncertainties.



- Do not lay down the modules and connecting materials on the work floor in such a way that people can fall over or trip over them.



- Never leave the modules and connection materials unattended on a scaffold so that they can fall down.
- Do not leave packaging materials on the shop floor to allow people to fall over or stumble, but dispose of them directly in the designated waste container.



- Do not dispose of cut pieces of cable on the work floor, but in the appropriate waste container.

If the following warnings, safety instructions and instructions are not followed, this can result in serious or fatal personal injury and (irreparable) damage to the DATALUX.LT system.

- **The DATALUX.LT may only be installed by a recognized installer.**
- **Switch off the general mains power before working on the system. Make sure that the power cannot be switched on accidentally. Cover switches and provide them with a safety label.**
- **Only use well insulated tools and use the tool for the purpose for which it was made!**
- **Ensure that sufficient daylight is available or use mobile lighting.**
- **Make sure that your connections (phase (s), ground and neutral) do not change when connected, this creates a life-threatening situation!**
- **Make sure that the electrical supply corresponds to the voltage and current required for the DATALUX.LT on the product label.**
- **When connecting the DATALUX.LT, refer to the connection overview in this manual and observe the locally applicable legal connection conditions (eg in the Netherlands: NEN 1010).**

© 2019 Luminaid

All rights reserved. No part of this installation manual may be reproduced and / or published by means of print, photocopy, microfilm or in any form whatsoever, without the written permission of Luminaid BV. This also applies to any drawings, diagrams and other attachments supplied. The information in this manual is based on the most recently known data. Luminaid BV reserves the right to change / improve parts at any time without prior or direct notification to the customer. The contents of this installation manual can also be changed without prior notification. This installation manual has been compiled with great care. Despite this care, Luminaid BV cannot accept responsibility for errors in this installation manual or for the consequences of such errors.